

# Panasonic

BUSINESS

## Panasonic PT-EZ590T

Flexibility and Performance to Meet Your Needs



Worldwide  
Olympic Partner



Worldwide  
Paralympic Partner





## Natural Pictures in Bright Rooms



### Reason

# 1

More than 30 years of hard-won experience stands behind every Panasonic projector we make. Innovative technology guarantees uncommonly bright and vivid pictures even in well-lit rooms.



## System Flexibility



### Reason

# 2

Long-reach single-cable AV control, powered lens shift/zoom/focus, and wide compatibility with existing infrastructure simplify and streamline setup for permanent or portable installations.

# Why Choose Panasonic?

People choose Panasonic because our products are dependable and meet the needs of professionals and educators. The versatile PT-EZ590 Series, for example, serves up immersive pictures in almost any situation, plug-and-play, with uncommonly low running costs. Like you, Panasonic projectors are working hard to deliver results of the highest quality.



## Low Total Cost of Ownership



### Reason

# 3

From dust-resistant construction to long-life UHM lamp, the PT-EZ590 Series is engineered for trouble-free operation with very low maintenance, saving you time and money.





**LCD Projectors**

**PT-EZ590 Series**

	PT-EZ590	PT-EW650	PT-EW550	PT-EX620	PT-EX520
Resolution	WUXGA	WXGA	WXGA	XGA	XGA
Brightness	5,400 lm	5,800 lm	5,000 lm	6,200 lm	5,300 lm
Contrast	10,000:1		2,000:1	10,000:1	2,000:1



Engineering / Art classes



Lecture theaters



Classrooms



Meeting rooms

**High Picture Quality**

**Compact and Stylish Projectors Deliver Up to 6,200 lm\*1 Brightness**

With up to 6,200 lm\*1 of brightness, the PT-EZ590 Series produces brilliant images even in high levels of artificial light. Text is clear and legible while graphics and video are reproduced with natural vibrancy.

**Dynamic Contrast of 10,000:1\*2 with Iris**

High dynamic contrast of 10,000:1\*2 is enabled by an iris mechanism, so that whites are brighter and blacks deeper with minimal loss of detail in dark images. The result is crisp and comfortable viewing.

**High WUXGA\*3 Resolution for Lush Detail**

With up to WUXGA\*3 (1920 x 1200) resolution, the PT-EZ590 Series is capable of displaying Full HD video. The extra detail and depth engages viewers for a more compelling presentation.

**Daylight View Basic Ensures Vivid Images in Bright Rooms**

Panasonic's original Daylight View Basic uses a built-in sensor to measure ambient light and calibrates image-projection to suit, optimizing brightness and halftone color and sharpening details for easy-to-see pictures in well-lit environments.



Conventional Projector



Daylight View Basic

**DICOM Simulation Mode for Medical Presentations**

This imaging mode is similar to the DICOM Part 14 medical imaging standard. It lends a film-like quality to X-ray images, making the PT-EZ590 Series suitable for training presentations related to medicine\*4.



Normal Mode



DICOM Simulation Mode

**Color Adjustment for Multi-screen Projection**

This function corrects subtle variations in the color reproduction range of individual units set up for multi-screen projection, particularly in side-by-side configuration.

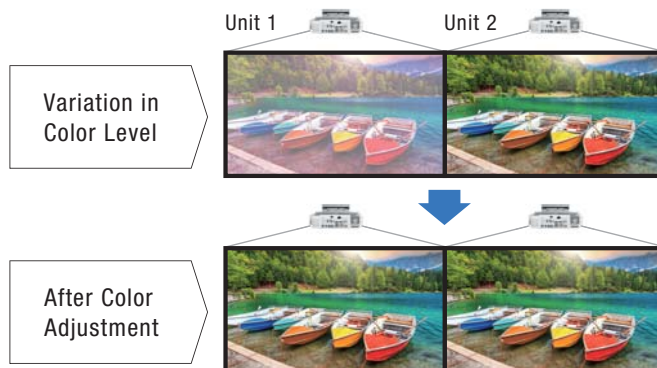

# Easy Setup and System Integration

## Flexible Layout with Multiple Projectors

DIGITAL LINK\* makes it quick and easy to select the appropriate display device when rearranging the venue to facilitate different types of presentations, such as lectures or group discussions.

\* For PT-EZ590/EZ590L, PT-EW650/EW650L, and PT-EX620/EX620L only.

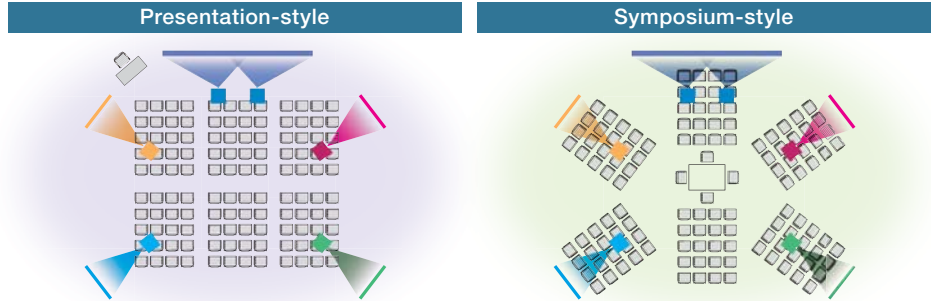

## Installation Simplified with DIGITAL LINK

PT-EZ590/EZ590L, PT-EW650/EW650L, and PT-EX620/EX620L feature a DIGITAL LINK connection that supports transmission of Full HD video, audio, and control signals through a single CAT 5e or higher STP cable for distances of up to 150 m (492 ft)\*5. An optional DIGITAL LINK Switcher or Digital Interface Box allows source devices to be connected and signals routed to the projector via one cable, saving installation cost and simplifying the AV system.

DIGITAL LINK is based on the HDBaseT™ communication standard developed by the HDBaseT Alliance with unique Panasonic functions added. This means peripheral HDBaseT™-compatible devices manufactured by other brands can be connected together with Panasonic products such as the ET-YFB200G for easy system control over the network.



DIGITAL LINK Switcher ET-YFB200G

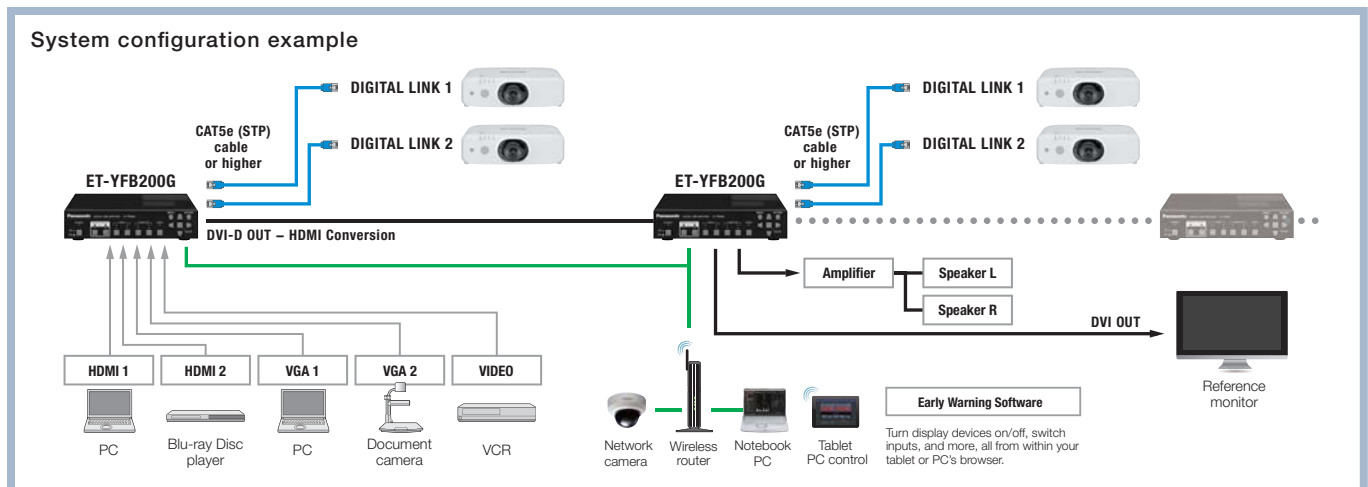

## Powered Lens Shift, Zoom, and Focus via Remote Control

The wide adjustment range of the powered horizontal/vertical lens-shift function assures convenience and versatility during installation. Zoom and focus are also easily adjusted via remote control.

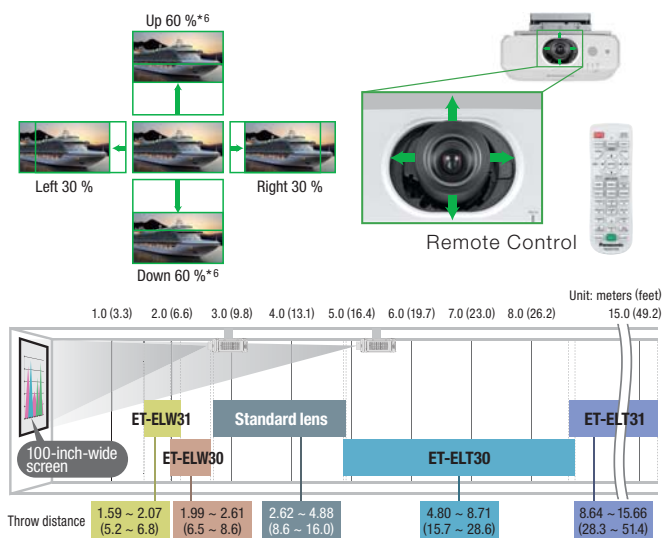

For PT-EZ590/EZ590L/EW650/EW650L/EW550L/EW550L (16:10 aspect ratio).

## Project onto Curved Surfaces

Horizontal, Vertical, and Corner Keystone Correction adjusts the image shape for clear visibility when projecting off-axis or from an unusual angle. Curved Screen Correction allows for the projection of natural, distortion-free images onto curved or cylindrical surfaces.

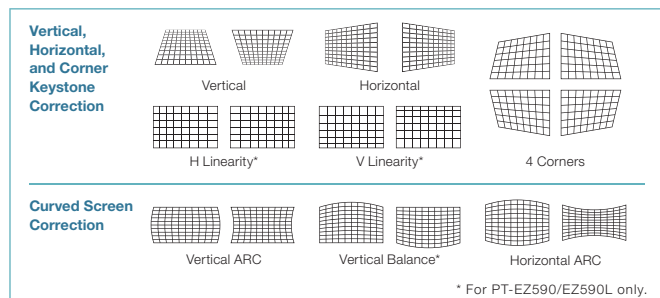

## Range of Optional Lenses

Choose from a selection of optional zoom lenses for your system. The additional lenses make it easier to adapt the projector to the installation site. Lenses attach and detach with one-touch ease.



## Mechanical Lens Shutter

A mechanical lens shutter prevents light leakage when the projector is on standby or temporarily not in use, such as periods during meetings.

Note: PT-EW550/EW550L and PT-EX520/EX520L feature an AV Mute function instead of a mechanical lens shutter.

## Lens-Centered Design

A symmetrical lens-centered design reduces installation complexity and makes these projectors easier to adapt to a wider range of installation sites.



## Project Wirelessly with Optional Module

The optional ET-WML100 wireless USB module enables projection of a variety of media via Windows® PCs, iOS devices, or Android™ devices loaded with an appropriate app. Whether projecting from desk or ceiling, there's no need for cables—and it's also possible to display content from more than one device at a time in Multi-Live Mode.



### Presenter Light Ver. 1.0 for Windows® PCs

- Stills, video, documents (including PDF and PowerPoint® files), and other media displayed on the PC screen can be wirelessly projected
- Images from up to four PCs can be projected simultaneously

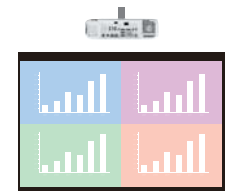

### VueMagic™ Pro\*7 for iOS/Android™ Devices

- Selected still images and document formats (including PDF files) are supported
- Features Live Camera Mode and Annotate Mode
- Images from up to four devices can be projected simultaneously



## Integrates into Existing AV Infrastructure

With support for PJLink™ Class 1, Crestron Connected, AMX, and RS-232C over wired LAN\*, any legacy unit can be swapped out for a PT-EZ590 Series projector without disrupting existing control and management infrastructure. Emulation via RS-232C allows original settings to be preserved. PT-EZ590 Series supports optional Early Warning Software that notifies the administrator ahead of time when part replacement is required.

\* Setting [Command Control] in the [Network Control] menu to ON enables projector control via LAN using control commands in Serial Input format. Please refer to the "Network Control" section in user manual for further details. Note that PT-EZ590 Series needs network connection request processes for individual commands. For more information, please visit our global website.

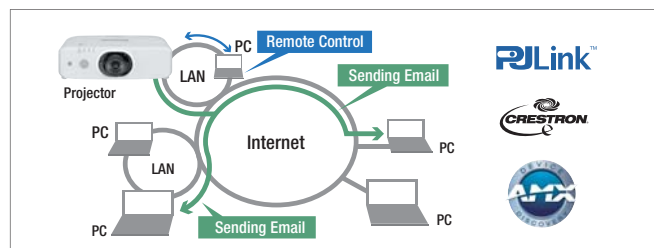

\*1 PT-EX620/EX620L features 6,200 lm, PT-EW650/EW650L 5,800 lm, PT-EZ590/EZ590L 5,400 lm, PT-EX520/EX520L 5,300 lm, and PT-EW550/EW550L 5,000 lm of brightness. \*2 PT-EW550/EW550L and PT-EX520/EX520L feature 2,000:1 contrast. \*3 PT-EZ590/EZ590L features WUXGA, PT-EW650/EW650L/EW550L WXGA, and PT-EX620/EX620L/EX520/EX520L XGA native resolution. \*4 This product is not a medical instrument. Do not use for actual medical diagnosis. \*5 150 m (492 ft) transmission available in Long Reach Mode with optional ET-YFB200G DIGITAL LINK Switcher only. Signal resolution is limited to 1080/60p (dot-clock frequency 148.5 MHz) and below. \*6 PT-EX620/EX620L/EX520/EX520L features up to 50 % lens shift. \*7 VueMagic™ Pro is a product of Pixelworks, Inc. For more information, please visit [vuemagic.pixelworks.com](http://vuemagic.pixelworks.com)



## Low Running Cost and Easy Maintenance

### Extended Lamp Replacement Cycle

PT-EZ590 Series projectors feature a lamp replacement cycle of up to 5,000 hours<sup>\*8</sup>. This helps to lower operating costs, reduce labor, and minimize wastage by extending the operation period between lamp maintenance.

### Dust-Resistant Cabinet and Extra-Long-Life Eco Filter

If dust gets inside the projector's optical unit, brightness suffers. The PT-EZ590 Series protects against dust intrusion with a one-way airflow design and improved sealing for the lens block, air intake duct, and Eco Filter. This electrostatic Micro Cut Filter captures the tiniest dust particles and requires no maintenance for 15,000 hours<sup>\*9</sup>. It also can be washed and reused<sup>\*10</sup>. These dust-resistant projectors are designed to maintain brightness for longer in high-traffic environments while reducing servicing costs.

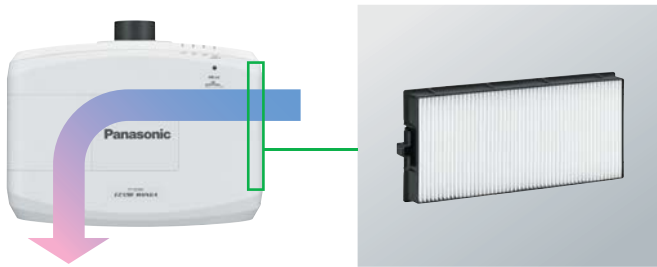

### ECO Management Slashes Power Consumption

A variety of Eco Management functions are accessible via a button on the remote controller. These include brightness optimization for ambient lighting conditions and lamp power reduction when no input signal is detected.



### Quiet Operation in ECO Mode

The quiet design reduces operating noise to just 29 dB<sup>\*11</sup>, with the sound of the cooling fan hardly noticeable. This helps to keep the audience focused on your presentation.

### Easy-Access Lamp and Filter

To reduce hassle, the filter can be replaced via the side and the lamp from the top of the projector. There's no need to remove the unit from its ceiling mount for periodic maintenance.



## Additional Features

- Power-saving Eco Standby Mode draws just 0.3 W<sup>\*12</sup>
- Direct Power Off enables safe projector shutdown via breaker switch
- Anti-theft measures include security bar, password protection, and personalized startup logo
- Supports free Multi Monitoring & Control Software
- 10 W speaker
- Closed Captioning (NTSC, 480i YCbCr)
- Schedule Function

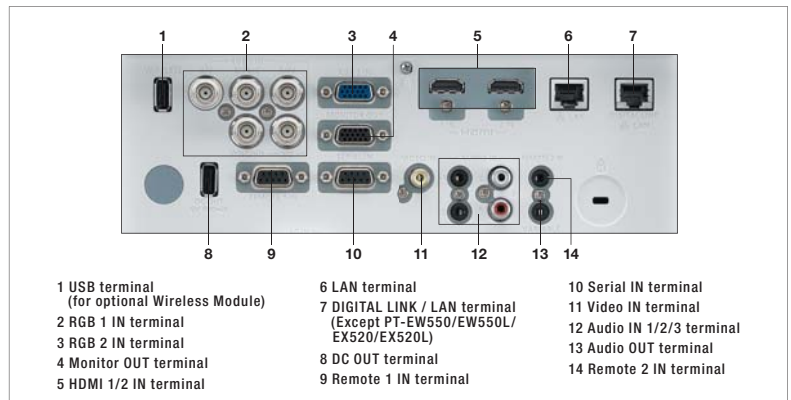

Terminals for PT-EZ590/EZ590L, PT-EW650/EW650L, and PT-EX620/EX620L shown.

<sup>\*8</sup> With lamp power set to ECO. Up to 4,000 hours with lamp power set to NORMAL. <sup>\*9</sup> Period varies depending on usage environment. <sup>\*10</sup> Follow user manual procedures when servicing filter. Replacement recommended after washing and reusing filter twice. If not sufficiently clean after washing, replacement is advised. <sup>\*11</sup> 35 dB with lamp power set to NORMAL. <sup>\*12</sup> When the Standby Mode is set to ECO, network functions such as Power On via LAN will not operate. Also, only certain commands can be received for external control using the serial terminal.

## Related Products

Featuring a Dual Eco Filter, this compact and essentially dustproof projector is ideal for use in classrooms of small to moderate size, and features DIGITAL LINK for ease of installation.



### LCD Projectors PT-FZ570 Series

PT-FZ570	WUXGA	4,500 lm	10,000:1
PT-FW530	WXGA	4,500 lm	10,000:1
PT-FX500	XGA	5,000 lm	10,000:1

## Projection Distance

PT-EZ590 / PT-EZ590L / PT-EW650 / PT-EW650L / PT-EW550 / PT-EW550L

unit: meters (feet)

Diagonal image size	Projection distance (L)*										Height from the edge of screen to center of lens (H)	
	Zoom lenses											
	ET-ELW31		ET-ELW30		Standard lens		ET-ELT30		ET-ELT31			
	min.	max.	min.	max.	min.	max.	min.	max.	min.	max.		
16:10 aspect ratio	1.02 (40")	0.62 (2.0)	0.81 (2.7)	0.78 (2.6)	1.03 (3.4)	1.03 (3.4)	1.94 (6.4)	1.86 (6.1)	3.42 (11.2)	3.53 (11.6)	6.35 (20.8)	-0.05 ~ 0.59 (-0.2 ~ 1.9)
	1.27 (50")	0.78 (2.6)	1.02 (3.3)	0.98 (3.2)	1.29 (4.2)	1.29 (4.2)	2.42 (7.9)	2.35 (7.7)	4.29 (14.1)	4.37 (14.3)	7.88 (25.9)	-0.07 ~ 0.74 (-0.2 ~ 2.4)
	1.52 (60")	0.94 (3.1)	1.23 (4.0)	1.18 (3.9)	1.55 (5.1)	1.55 (5.1)	2.91 (9.5)	2.83 (9.3)	5.16 (16.9)	5.21 (17.1)	9.41 (30.9)	-0.08 ~ 0.89 (-0.3 ~ 2.9)
	1.78 (70")	1.10 (3.6)	1.44 (4.7)	1.39 (4.6)	1.82 (6.0)	1.82 (6.0)	3.41 (11.2)	3.33 (10.9)	6.06 (19.9)	6.08 (19.9)	11.00 (36.1)	-0.09 ~ 1.04 (-0.3 ~ 3.4)
	2.03 (80")	1.26 (4.1)	1.65 (5.4)	1.59 (5.2)	2.08 (6.8)	2.09 (6.9)	3.89 (12.8)	3.82 (12.5)	6.93 (22.7)	6.93 (22.7)	12.54 (41.1)	-0.11 ~ 1.18 (-0.4 ~ 3.9)
	2.29 (90")	1.43 (4.7)	1.87 (6.1)	1.79 (5.9)	2.35 (7.7)	2.36 (7.7)	4.40 (14.4)	4.32 (14.2)	7.84 (25.7)	7.80 (25.6)	14.13 (46.4)	-0.12 ~ 1.34 (-0.4 ~ 4.4)
	2.54 (100")	1.59 (5.2)	2.07 (6.8)	1.99 (6.5)	2.61 (8.6)	2.62 (8.6)	4.88 (16.0)	4.80 (15.7)	8.71 (28.6)	8.64 (28.3)	15.66 (51.4)	-0.13 ~ 1.48 (-0.4 ~ 4.9)
	3.05 (120")	1.91 (6.3)	2.5 (8.2)	2.40 (7.9)	3.14 (10.3)	3.15 (10.3)	5.87 (19.3)	5.79 (19.0)	10.49 (34.4)	10.35 (34.0)	18.79 (61.6)	-0.16 ~ 1.78 (-0.5 ~ 5.8)
	3.81 (150")	2.40 (7.9)	3.13 (10.3)	3.01 (9.9)	3.93 (12.9)	3.94 (12.9)	7.34 (24.1)	7.26 (23.8)	13.13 (43.1)	12.91 (42.4)	23.44 (76.9)	-0.20 ~ 2.22 (-0.7 ~ 7.3)
	5.08 (200")	3.21 (10.5)	4.18 (13.7)	4.02 (13.2)	5.25 (17.2)	5.27 (17.3)	9.79 (32.1)	9.71 (31.9)	17.55 (57.6)	17.18 (56.4)	31.23 (102.5)	-0.27 ~ 2.96 (-0.9 ~ 9.7)
	6.35 (250")	4.01 (13.2)	5.23 (17.2)	5.03 (16.5)	6.57 (21.6)	6.59 (21.6)	12.25 (40.2)	12.17 (39.9)	21.98 (72.1)	21.45 (70.4)	39.01 (128.0)	-0.34 ~ 3.70 (-1.1 ~ 12.1)
	7.62 (300")	4.82 (15.8)	6.29 (20.6)	6.05 (19.8)	7.89 (25.9)	7.92 (26.0)	14.71 (48.3)	14.63 (48.0)	26.40 (86.6)	25.72 (84.4)	46.79 (153.5)	-0.40 ~ 4.44 (-1.3 ~ 14.6)
10.16 (400")	6.44 (21.1)	8.39 (27.5)	8.07 (26.5)	10.53 (34.5)	10.57 (34.7)	19.62 (64.4)	19.54 (64.1)	35.25 (115.6)	34.26 (112.4)	62.36 (204.6)	-0.54 ~ 5.92 (-1.8 ~ 19.4)	
16:9 aspect ratio	1.02 (40")	0.64 (2.1)	0.84 (2.8)	0.80 (2.6)	1.06 (3.5)	1.06 (3.5)	1.99 (6.5)	1.92 (6.3)	3.51 (11.5)	3.62 (11.9)	6.52 (21.4)	-0.08 ~ 0.58 (-0.3 ~ 1.9)
	1.27 (50")	0.80 (2.6)	1.05 (3.4)	1.01 (3.3)	1.32 (4.3)	1.33 (4.4)	2.49 (8.2)	2.41 (7.9)	4.41 (14.5)	4.49 (14.7)	8.09 (26.5)	-0.10 ~ 0.73 (-0.3 ~ 2.4)
	1.52 (60")	0.96 (3.1)	1.26 (4.1)	1.21 (4.0)	1.59 (5.2)	1.60 (5.2)	2.99 (9.8)	2.91 (9.5)	5.30 (17.4)	5.35 (17.6)	9.67 (31.7)	-0.12 ~ 0.87 (-0.4 ~ 2.9)
	1.78 (70")	1.13 (3.7)	1.48 (4.9)	1.43 (4.7)	1.87 (6.1)	1.88 (6.2)	3.51 (11.5)	3.43 (11.3)	6.23 (20.4)	6.25 (20.5)	11.31 (37.1)	-0.15 ~ 1.02 (-0.5 ~ 3.3)
	2.03 (80")	1.30 (4.3)	1.70 (5.6)	1.63 (5.3)	2.13 (7.0)	2.14 (7.0)	4.0 (13.1)	3.92 (12.9)	7.13 (23.4)	7.12 (23.4)	12.88 (42.3)	-0.17 ~ 1.16 (-0.6 ~ 3.8)
	2.29 (90")	1.47 (4.8)	1.92 (6.3)	1.84 (6.0)	2.41 (7.9)	2.42 (7.9)	4.52 (14.8)	4.44 (14.6)	8.06 (26.4)	8.01 (26.3)	14.52 (47.6)	-0.19 ~ 1.31 (-0.6 ~ 4.3)
	2.54 (100")	1.63 (5.3)	2.13 (7.0)	2.05 (6.7)	2.68 (8.8)	2.69 (8.8)	5.02 (16.5)	4.94 (16.2)	8.96 (29.4)	8.88 (29.1)	16.09 (52.8)	-0.21 ~ 1.45 (-0.7 ~ 4.8)
	3.05 (120")	1.97 (6.5)	2.57 (8.4)	2.47 (8.1)	3.22 (10.6)	3.24 (10.6)	6.03 (19.8)	5.95 (19.5)	10.78 (35.4)	10.64 (34.9)	19.31 (63.4)	-0.25 ~ 1.74 (-0.8 ~ 5.7)
	3.81 (150")	2.46 (8.1)	3.21 (10.5)	3.09 (10.1)	4.04 (13.3)	4.05 (13.3)	7.54 (24.7)	7.46 (24.5)	13.50 (44.3)	13.27 (43.5)	24.09 (79.0)	-0.31 ~ 2.18 (-1.0 ~ 7.2)
	5.08 (200")	3.30 (10.8)	4.30 (14.1)	4.13 (13.5)	5.39 (17.7)	5.42 (17.8)	10.07 (33.0)	9.99 (32.8)	18.05 (59.2)	17.66 (57.9)	32.09 (105.3)	-0.42 ~ 2.90 (-1.4 ~ 9.5)
	6.35 (250")	4.13 (13.5)	5.38 (17.7)	5.17 (17.0)	6.75 (22.1)	6.78 (22.2)	12.59 (41.3)	12.51 (41.0)	22.59 (74.1)	22.04 (72.3)	40.09 (131.5)	-0.52 ~ 3.63 (-1.7 ~ 11.9)
	7.62 (300")	4.96 (16.3)	6.46 (21.2)	6.22 (20.4)	8.11 (26.6)	8.14 (26.7)	15.11 (49.6)	15.04 (49.3)	27.14 (89.0)	26.43 (86.7)	48.09 (157.8)	-0.62 ~ 4.36 (-2.0 ~ 14.3)
10.16 (400")	6.62 (21.7)	8.63 (28.3)	8.30 (27.2)	10.82 (35.5)	10.86 (35.6)	20.16 (66.1)	20.09 (65.9)	36.23 (118.9)	35.21 (115.5)	64.09 (210.3)	-0.83 ~ 5.81 (-2.7 ~ 19.1)	

PT-EX620 / EX620L, PT-EX520 / EX520L

unit: meters (feet)

Diagonal image size	Projection distance (L)*										Height from the edge of screen to center of lens (H)	
	Zoom lenses											
	ET-ELW31		ET-ELW30		Standard lens		ET-ELT30		ET-ELT31			
	min.	max.	min.	max.	min.	max.	min.	max.	min.	max.		
4:3 aspect ratio	1.02 (40")	0.63 (2.1)	0.90 (3.0)	0.80 (2.6)	1.05 (3.4)	1.05 (3.4)	1.98 (6.5)	1.90 (6.2)	3.51 (11.5)	3.60 (11.8)	6.46 (21.2)	0.00 ~ 0.61 (0.0 ~ 2.0)
	1.27 (50")	0.79 (2.6)	1.11 (3.6)	1.00 (3.3)	1.31 (4.3)	1.32 (4.3)	2.47 (8.1)	2.39 (7.8)	4.39 (14.4)	4.45 (14.6)	8.03 (26.3)	0.00 ~ 0.76 (0.0 ~ 2.5)
	1.52 (60")	0.95 (3.1)	1.32 (4.3)	1.20 (3.9)	1.58 (5.2)	1.58 (5.2)	2.96 (9.7)	2.88 (9.4)	5.28 (17.3)	5.31 (17.4)	9.59 (31.5)	0.00 ~ 0.91 (0.0 ~ 3.0)
	1.78 (70")	1.12 (3.7)	1.54 (5.1)	1.41 (4.6)	1.85 (6.1)	1.86 (6.1)	3.47 (11.4)	3.39 (11.1)	6.20 (20.3)	6.20 (20.3)	11.21 (36.8)	0.00 ~ 1.07 (0.0 ~ 3.5)
	2.03 (80")	1.29 (4.2)	1.75 (5.7)	1.62 (5.3)	2.12 (7.0)	2.12 (7.0)	3.97 (13.0)	3.89 (12.8)	7.09 (23.3)	7.06 (23.2)	12.77 (41.9)	0.00 ~ 1.22 (0.0 ~ 4.0)
	2.29 (90")	1.45 (4.8)	1.97 (6.5)	1.83 (6.0)	2.39 (7.8)	2.40 (7.9)	4.48 (14.7)	4.40 (14.4)	8.01 (26.3)	7.95 (26.1)	14.40 (47.2)	0.00 ~ 1.37 (0.0 ~ 4.5)
	2.54 (100")	1.62 (5.3)	2.18 (7.2)	2.03 (6.7)	2.66 (8.7)	2.67 (8.8)	4.97 (16.3)	4.89 (16.0)	8.89 (29.2)	8.80 (28.9)	15.96 (52.4)	0.00 ~ 1.52 (0.0 ~ 5.0)
	3.05 (120")	1.95 (6.4)	2.61 (8.6)	2.45 (8.0)	3.20 (10.5)	3.21 (10.5)	5.98 (19.6)	5.90 (19.4)	10.70 (35.1)	10.55 (34.6)	19.14 (62.8)	0.00 ~ 1.83 (0.0 ~ 6.0)
	3.81 (150")	2.44 (8.0)	3.26 (10.7)	3.06 (10.0)	4.00 (13.1)	4.02 (13.2)	7.47 (24.5)	7.39 (24.2)	13.40 (44.0)	13.16 (43.2)	23.89 (78.4)	0.00 ~ 2.29 (0.0 ~ 7.5)
	5.08 (200")	3.27 (10.7)	4.33 (14.2)	4.10 (13.5)	5.35 (17.6)	5.37 (17.6)	9.98 (32.7)	9.90 (32.5)	17.90 (58.7)	17.51 (57.4)	31.82 (104.4)	0.00 ~ 3.05 (0.0 ~ 10.0)
	6.35 (250")	4.09 (13.4)	5.40 (17.7)	5.13 (16.8)	6.69 (21.9)	6.72 (22.0)	12.48 (40.9)	12.40 (40.7)	22.40 (73.5)	21.86 (71.7)	39.75 (130.4)	0.00 ~ 3.81 (0.0 ~ 12.5)
	7.62 (300")	4.91 (16.1)	6.48 (21.3)	6.16 (20.2)	8.04 (26.4)	8.07 (26.5)	14.98 (49.1)	14.90 (48.9)	26.91 (88.3)	26.21 (86.0)	46.68 (156.4)	0.00 ~ 4.57 (0.0 ~ 15.0)
10.16 (400")	6.56 (21.5)	8.62 (28.3)	8.22 (27.0)	10.73 (35.2)	10.77 (35.3)	19.99 (65.6)	19.91 (65.3)	35.91 (117.8)	34.91 (114.5)	63.55 (208.5)	0.00 ~ 6.10 (0.0 ~ 20.0)	

\* The value for L (distance to screen) varies slightly within ±5 % depending on the zoom lens characteristics.

Note: The zoom lens characteristics may cause slight image distortion. When vertical keystone correction is used, the image is corrected in the direction that reduces its projected size.

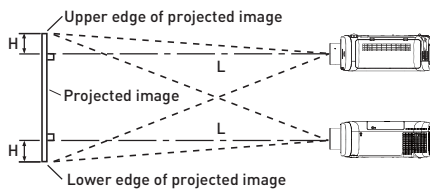

## Dimensions

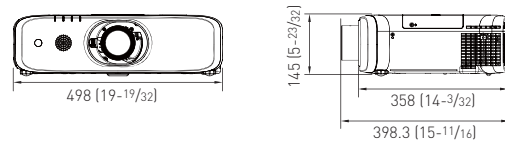

unit: mm (inch)

## Optional Accessories

<b>Zoom Lens</b> ET-ELW31 	<b>Zoom Lens</b> ET-ELW30 	<b>Zoom Lens</b> ET-ELT30 	<b>Zoom Lens</b> ET-ELT31 	<b>Replacement Lamp Unit</b> ET-LAEF100 
<b>Ceiling Mount Bracket (for High Ceiling)</b> ET-PKD120H 	<b>Ceiling Mount Bracket (for Low Ceiling)</b> ET-PKD120S 	<b>Projector Mount Bracket</b> ET-PKE300B 	<b>Replacement Filter Unit</b> ET-RFE300 	<b>D-sub/S-VIDEO Conversion Cable</b> ET-ADSV 
<b>DIGITAL LINK Switcher</b> ET-YFB200G 	<b>Digital Interface Box</b> ET-YFB100G 	<b>Wireless Module</b> ET-WML100 	<b>Early Warning Software</b> ET-SWA100 series 	

## Specifications

Model	PT-EZ590/EZ590L	PT-EW650/EW650L	PT-EW550/EW550L	PT-EX620/EX620L	PT-EX520/EX520L	
Power supply	100–240 V AC, 50/60 Hz					
Power consumption	484 W, Normal: 444 W, Eco: 325 W (0.3 W with Standby Mode set to Eco <sup>*1</sup> , 12 W with Standby Mode set to Normal)   461 W, Normal: 424 W, Eco: 305 W (0.3 W with Standby Mode set to Eco <sup>*1</sup> , 12 W with Standby Mode set to Normal)   461 W, Normal: 424 W, Eco: 305 W (0.3 W with Standby Mode set to Eco <sup>*1</sup> , 8 W with Standby Mode set to Normal)   461 W, Normal: 424 W, Eco: 305 W (0.3 W with Standby Mode set to Eco <sup>*1</sup> , 12 W with Standby Mode set to Normal)   461 W, Normal: 424 W, Eco: 305 W (0.3 W with Standby Mode set to Eco <sup>*1</sup> , 8 W with Standby Mode set to Normal)					
LCD panel	Panel size: 16.3 mm (0.64") diagonal (16:10 aspect ratio)					
	Display method: Transparent LCD panel (× 3, R/G/B)					
	Drive method: Active matrix					
	Pixels: 2,304,000 (1920 × 1200) × 3, total of 6,912,000 pixels   1,024,000 (1280 × 800) × 3, total of 3,072,000 pixels   786,432 (1024 × 768) × 3, total of 2,359,296 pixels					
Lens	PT-EZ590/EW650/EW550: Powered 1.8 x zoom (throw ratio 1.22–2.26:1), powered focus F 1.6–2.2, f17.1–31.7 mm PT-EZ590L/EW650L/EW550L: Optional powered zoom/focus lenses			PT-EX620/EX520: Powered 1.8 x zoom (throw ratio 1.32–2.44:1), powered focus F 1.6–2.2, f17.1–31.7 mm, PT-EX620L/EX520L: Optional powered zoom/focus lenses		
Lamp	320 W UHM lamp × 1					
Lamp replacement cycle	4,000 hours <sup>*2</sup> (Lamp Power: Normal), 5,000 hours <sup>*2</sup> (Lamp Power: Eco)					
Screen size (diagonal)	1.03–10.57 m (40–400 in), 16:10 aspect ratio			1.05–10.77 m (40–400 in), 4:3 aspect ratio		
Brightness <sup>*3</sup>	5,400 lm (Lamp Power: Normal, Dynamic Mode, Iris: OFF, Daylight View: OFF, Auto Power Save: OFF)		5,800 lm (Lamp Power: Normal, Dynamic Mode, Iris: OFF, Daylight View: OFF, Auto Power Save: OFF)		5,000 lm (Lamp Power: Normal, Dynamic Mode, Iris: OFF, Daylight View: OFF, Auto Power Save: OFF)	
Center-to-corner uniformity <sup>*3</sup>	90 %					
Contrast <sup>*3</sup>	10,000:1 (Lamp Power: Normal, Dynamic Mode, Iris: ON, Daylight View: OFF, Auto Power Save: OFF)		2,000:1 (Lamp Power: Normal, Dynamic Mode, Iris: ON, Daylight View: OFF, Auto Power Save: OFF)		10,000:1 (Lamp Power: Normal, Dynamic Mode, Iris: ON, Daylight View: OFF, Auto Power Save: OFF)   2,000:1 (Lamp Power: Normal, Dynamic Mode, Iris: ON, Daylight View: OFF, Auto Power Save: OFF)	
Resolution	1920 × 1200 pixels		1280 × 800 pixels <sup>*4</sup>		1024 × 768 pixels <sup>*4</sup>	
Scanning frequency	HDMI/DIGITAL LINK: fh: 15 kHz–90 kHz, fv: 24 Hz–100 Hz, dot clock: 25 MHz–162 MHz, compatible with HDCP. DIGITAL LINK not included on PT-EW550/EW550L/EX520/EX520L.					
	RGB: fh: 15 kHz–90 kHz, fv: 24 Hz–100 Hz, dot clock: up to 162 MHz					
	YPbPr (YCbCr): fh: 15.73 kHz, fv: 59.94 Hz [480i (525)], fh: 15.63 kHz, fv: 50 Hz [576i (625)], fh: 45.00 kHz, fv: 60 Hz [720 (750)/60p], fh: 33.75 kHz, fv: 60 Hz [1080 (1125)/60p], fh: 28.13 kHz, fv: 25 Hz [1080 (1125)/25p], fh: 27.00 kHz, fv: 48 Hz [1080 (1125)/24p], fh: 67.50 kHz, fv: 60 Hz [1080 (1125)/60p], fh: 31.47 kHz, fv: 59.94 Hz [480p (525p)], fh: 31.25 kHz, fv: 50 Hz [576p (625p)], fh: 37.50 kHz, fv: 50 Hz [720 (750)/50p], fh: 28.13 kHz, fv: 50 Hz [1080 (1125)/50p], fh: 27.00 kHz, fv: 24 Hz [1080 (1125)/24p], fh: 33.75 kHz, fv: 30 Hz [1080 (1125)/30p], fh: 56.25 kHz, fv: 50 Hz [1080 (1125)/50p]					
	Video/YC: fh: 15.73 kHz, fv: 59.94 Hz [NTSC/NTSC4.43/PAL-M/PAL60], fh: 15.63 kHz, fv: 50 Hz [PAL/PAL-N/SECAM]					
Optical axis shift	Vertical (from center of screen): ±60 % (powered)			±50 % (powered)		
	Horizontal (from center of screen): ±30 % (powered)					
Keystone correction range <sup>*5</sup>	Vertical: ±25 °, horizontal: ±30 °		Vertical: ±35 °, horizontal: ±35 °			
Installation	Ceiling/floor, front/rear					
Built-in speaker	4.0 cm (monaural) x 1					
Terminals	HDMI: HDMI 19-pin × 2 (Deep Color, compatible with HDCP), audio signal: Linear PCM (Sampling frequency: 48 kHz/44.1 kHz/32 kHz)					
	RGB 1 IN: BNC × 5 (RGB or YPbPr/YCbCr x 1), shared with VIDEO IN (S-video/composite video)					
	RGB 2 IN: Mini D-sub 15-pin (female) x 1					
	VIDEO IN: Pin jack x 1 (composite video)					
	MONITOR OUT: Mini D-sub 15-pin (female) x 1 (RGB x 1) (compatible with RGB or YPbPr/YCbCr)					
	AUDIO IN: Pin jack x 2 (L/R x 1), M3 x 2 (L-R x 2)					
	AUDIO OUT: M3 x 1 (L-R x 1) for output (variable)					
	SERIAL IN: D-sub 9-pin (female) x 1 for external control (RS-232C compliant)					
	REMOTE 1 IN: D-sub 9-pin (female) x 1 for external control (parallel)					
	REMOTE 2 IN: M3 × 1 for wired remote control					
	LAN: RJ-45 x 1 for network connection, 10Base-T, 100Base-TX, compatible with PLink™					
	DIGITAL LINK / LAN: RJ-45 x 1 for network and DIGITAL LINK connection, 100Base-TX, compatible with PLink™, HDCP, Deep Color		—		RJ-45 x 1 for network and DIGITAL LINK connection, 100Base-TX, compatible with PLink™, HDCP, Deep Color	—
	USB-A: USB terminal for optional Wireless Module (ET-WML100) x 1, DC output terminal for power supply (DC 5 V, up to 900 mA) x 1					
	Operating noise <sup>*3</sup>	35 dB (Lamp Power: Normal), 29 dB (Lamp Power: Eco)				
Filter	× 1, replacement cycle: up to 15,000 hours <sup>*6</sup>					
Mechanical shutter	Yes		— (AV mute)		Yes	
Cabinet materials	Molded plastic (PC + ABS)					
Dimensions (W × H × D)	PT-EZ590/EW650/EW550/EX620/EX520: 498 x 145 <sup>*7</sup> x 398.3 mm (19 19/32" × 5 23/32" × 15 11/16") (with supplied lens) PT-EZ590L/EW650L/EW550L/EX620L/EX520L: 498 x 145 <sup>*7</sup> x 358 mm (19 19/32" × 5 23/32" × 14 3/32") (without lens)					
Weight <sup>*8</sup>	PT-EZ590/EW650/EW550/EX620/EX520: Approximately 8.4 kg (18.5 lbs) (with supplied lens) PT-EZ590L/EW650L/EW550L/EX620L/EX520L: Approximately 7.7 kg (17.0 lbs) (without lens)					
Operating environment	Operating temperature: 0 °C–45 °C (32 °F–113 °F) <sup>*9</sup> , operating humidity: 20 %–80 % (no condensation)					
Supplied accessories	Power cord with power cord holder <sup>*10</sup> , wireless remote control unit × 1, batteries (R03/LR03/AAA type × 2), Software CD-ROM × 1 (Logo Transfer Software, Multi Monitoring and Control Software)					

Note: The PT-EZ590L/EW650L/EW550L/EX620L/EX520L delivers the same performance as the PT-EZ590/EW650/EW550/EX620/EX520, but comes without a lens. \*1 When Standby Mode is set to Eco, network functions such as power on over LAN will not operate. Also, only certain commands can be received for external control using the serial terminal. \*2 This is the maximum value when the lamp is turned on for 2 hours and off for 0.25 hours. If the lamp is turned on more frequently or kept on for a long time, lamp replacement cycle will be reduced. Usage environment affects the duration of the lamp. \*3 Measurement, measuring conditions, and method of notation all comply with ISO 21118 international standards. \*4 Input signals that exceed supported resolution will be converted. \*5 With the supplied lens. Value differs when the correction for both directions is operated. \*6 Usage environment affects the duration of the filter. \*7 With legs at shortest position. \*8 Average value. May differ depending on models. \*9 At altitudes below 1,400 m (4,593 ft) above sea level. Operating temperature range is 0 °C to 40 °C (32 °F to 104 °F) when used at altitudes from 1,400 m to 2,700 m (4,593 ft to 8,858 ft) above sea level. Also, if ambient temperature exceeds 40 °C (104 °F) (35 °C [95 °F] at high altitude), lamp power automatically switches to Eco in order to protect the projector. \*10 Power cords available (x2) for Europe, the UK and Asia only.

# Panasonic®



For more information about Panasonic projectors, please visit:  
 Projector Global Website – [panasonic.net/avc/projector](http://panasonic.net/avc/projector)  
 Facebook – [www.facebook.com/panasonicprojector](https://www.facebook.com/panasonicprojector)  
 YouTube – [www.youtube.com/user/PanasonicProjector](https://www.youtube.com/user/PanasonicProjector)

All information included here is valid as of October 2016.

PT-EZ590G2 Printed in Japan.

Weights and dimensions shown are approximate. Specifications and appearance are subject to change without notice. Product availability differs depending on region and country. This product may be subject to export control regulations. HDMI, the HDMI logo, and High-Definition Multimedia Interface are trademarks or registered trademarks of HDMI Licensing LLC in the United States and other countries. The PLink trademark is an application trademark in Japan, the United States, and other countries and regions or registered trademarks. All other trademarks are the property of their respective trademark owners. 36 USC 220506 © 2016 Panasonic Corporation. All rights reserved.